

NEW

**Picking Box Air
RK Box Air**

**System ST
Visual Box**



fair

BREATHE THE EVOLUTION

index

03	WE REDESIGNED EMPTINESS
04	STACK AND SAVE SPACE
06	ADAPTABLE BY DESIGN
07	STRONG AIR
10	REVOLUTIONIZE LOGISTICS
12	LESS SPACE, MORE AIR
15	RK BOX AIR
16	SYSTEM ST
17	INDEX NEW PRODUCTS 2024

We redesigned emptiness

Fill, empty, move. And repeat again. Empty-full is the rhythm that gives life to companies, making containers the hidden heroes of every industrial sector. Hidden, but vital. This continuous rhythm - empty, full, move - is the company's heartbeat, with the containers playing an essential, but silent role in the complex industrial symphony.

This has been a real challenge for us. After having restyled the entire company during recent years, we decided to redesign the simplest brick in our product catalogue: the plastic container. This is why Air was born.

Air is the synthesis of innovation, design, and practical use. Compared to containers of the same size, Air offers greater storage capacity with a 50% reduction in spatial dimensions.

Just as leaves convert light into life, Air transforms storage into sustainability.

Riempi, svuota, sposta. E ripeti ancora. Vuoto-pieno è il ritmo che dà vita alle aziende, rendendo i contenitori gli eroi nascosti di ogni settore industriale. Nascosti, ma vitali. Questo ritmo continuo - vuoto, pieno, movimento - è il respiro dell'azienda, con i contenitori che giocano un ruolo chiave, ma silenzioso, nella complessa sinfonia industriale.

Per noi questa è stata una vera sfida. Dopo aver ridisegnato l'intera azienda negli ultimi anni, abbiamo deciso di riprogettare il mattoncino più semplice del nostro catalogo prodotti: il contenitore in plastica. Per questo è nato Air. Air è la sintesi di innovazione, design e praticità. Rispetto a contenitori di pari dimensioni Air offre maggior capacità contenitiva con una riduzione del 50% dell'ingombro spaziale.

Proprio come le foglie convertono la luce in vita, Air trasforma lo stoccaggio in sostenibilità.

AIR
BREATHE
THE EVOLUTION



FAMI S.r.l.
Via Stazione Rossano, 13
36027 Rosà (VI) - Italy
Tel +39 0424 585455
Fax +39 0424 585470
commerciale@famispaspa.com

FAMI EXPORT DEPT.
Tel +39 0424 585455
Fax +39 0424 585472
export@famispaspa.com

info@famispaspa.com
www.famispaspa.com

FAMI ONLINE STORE
shop.famispaspa.com

Fami Srl fami_storage_systems
 Fami Srl FAMI S.r.l.



AIR
BREATHE
THE EVOLUTION

STACK smart, SAVE space. MORE space.

By nesting the Picking Box Air containers together, you can save 50% of the space needed in logistics. Less space occupied means less movements required on the Europallets, with a notable reduction in consumption and environmental impact. One shelf is enough when previously two were needed.

Annidando tra loro i Picking Box Air si ottiene un risparmio del 50% dello spazio necessario nella logistica. Meno spazio occupato significa meno movimentazioni necessarie sugli Europallet, con una notevole riduzione dei consumi e dell'impatto ambientale. Basta uno scaffale quando prima ne servivano due.



Adaptable by design

When creating Air, we embraced a vision: sustainability means enhancing today's resources for tomorrow's results. This is why the Picking Box Air by FAMI is designed for perfect compatibility with numerous other containers dedicated to picking.

Each detail in AIR is designed to have a precise functionality, as well as to provide sturdy aesthetics to the product:

- compatibility with Picking Box on the market
- adaptability to the FAMI system
- ergonomic front access
- wear resistance
- containment and distribution of weight forces
- stackable
- nestable

Ogni segno in AIR è concepito con delle precise funzionalità, oltre a conferire un'estetica muscolosa al prodotto:

- compatibilità con Picking Box in commercio
- adattabilità al sistema FAMI
- accesso frontale ergonomico
- resistenza all'usura
- contenimento e dissipazione delle forze peso
- impilabilità
- annidabilità

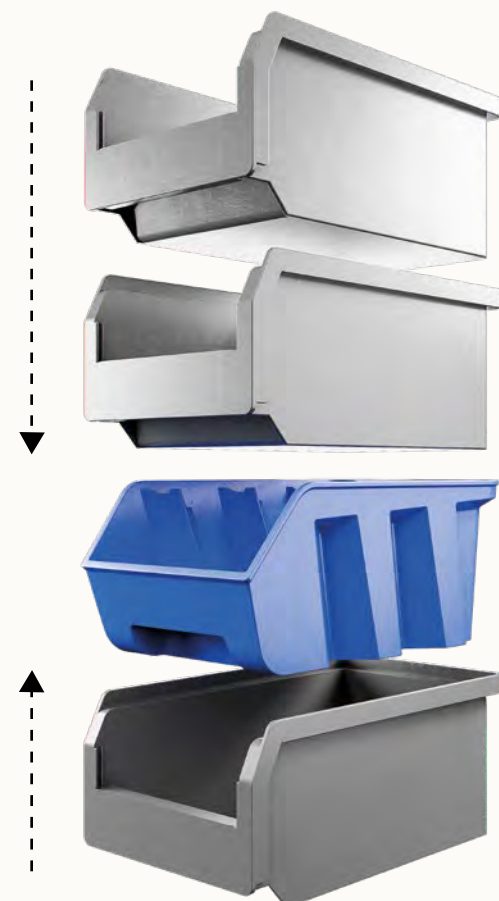
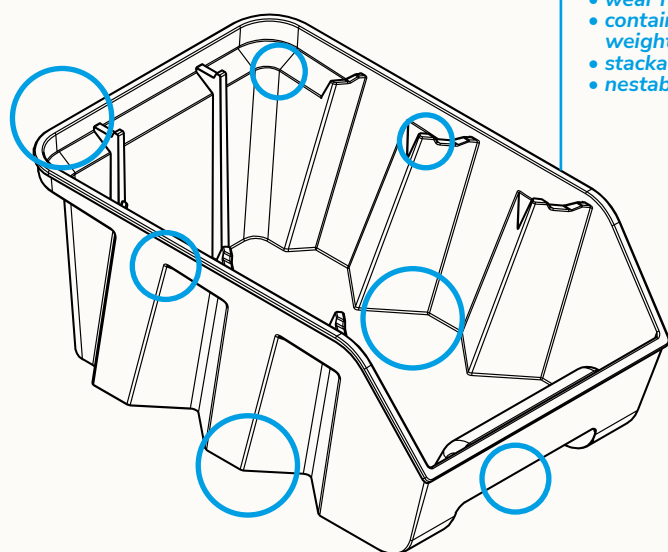

Nel creare Air, abbiamo abbracciato una visione: sostenibilità significa valorizzare le risorse di oggi per i risultati di domani. Ecco perché Picking Box Air di FAMI è progettato per una perfetta compatibilità con numerosi altri contenitori dedicati al picking.



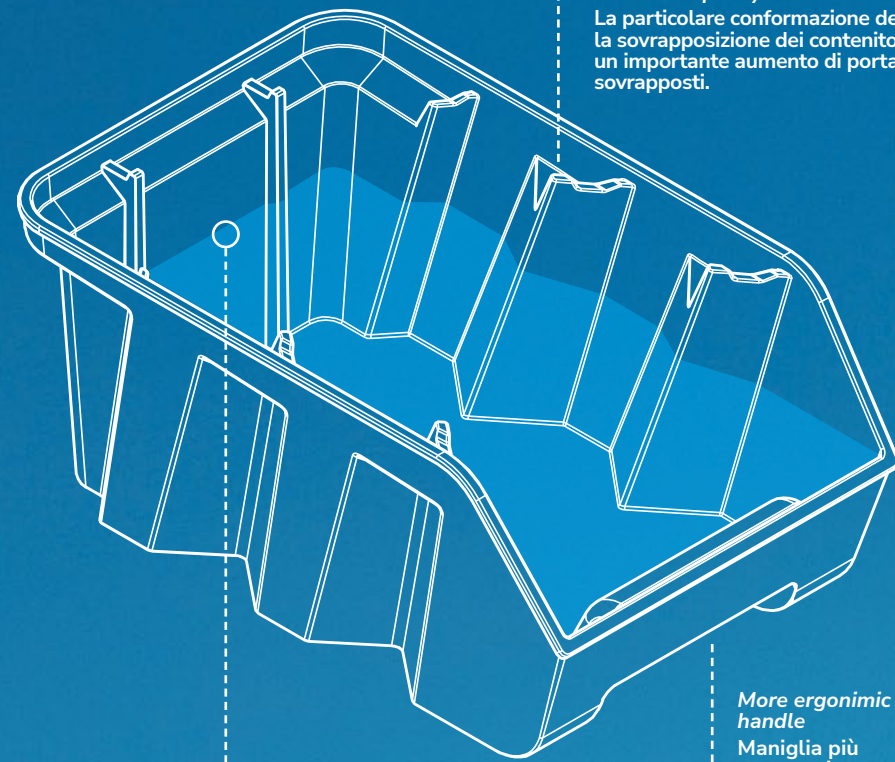

The special shape of the inserts for stacking the containers allows a significant increase in the load capacity of the stacked weights.
La particolare conformazione degli inserti per la sovrapposizione dei contenitori permette un importante aumento di portata dei pesi sovrapposti.

More ergonomic handle
Maniglia più ergonomica

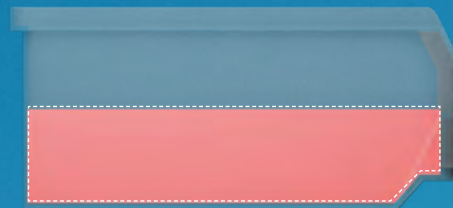

Picking Box Classic



Picking Box Air

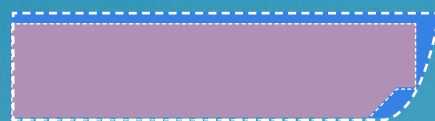

Greater storage capacity
Maggiore capacità di stoccaggio

Highly resistant functional lever compatible with the FAMI system
Leva funzionale ad alta tenuta compatibile con sistema FAMI

Wider access
Accesso più ampio

Strong Air

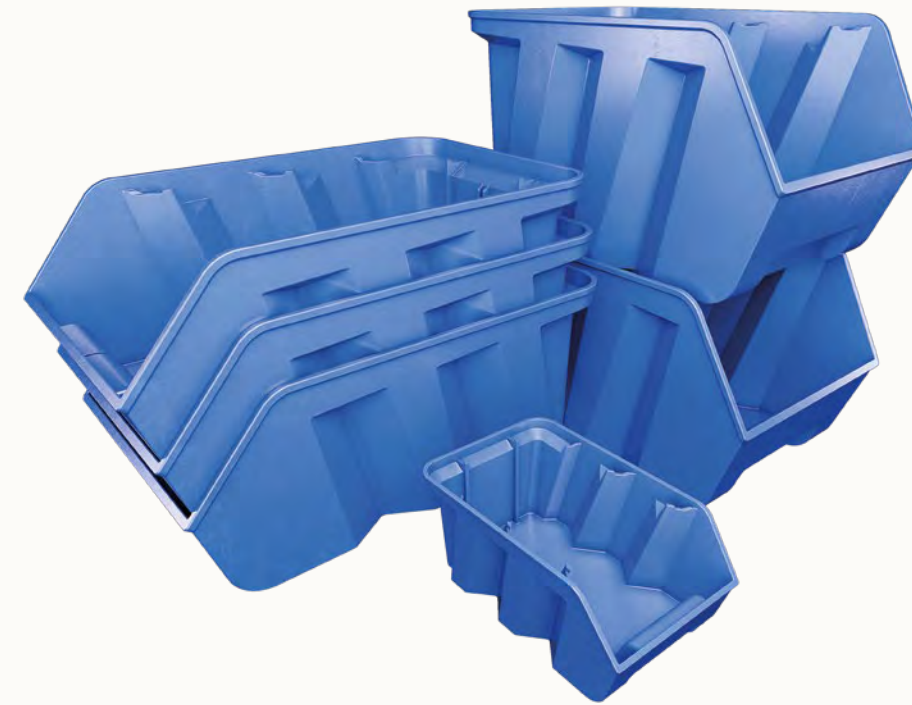

We developed Air to revolutionise our plastic containers dedicated to picking: the structure is reinforced, the front wall with a hopper-type opening expands the container's capacity and at the same time increases its ergonomics. This innovation embodies our commitment not only to improving functionality, but also to ensuring a more comfortable and efficient use. Experience the next level of storage solutions with Air, where strength meets design.

Abbiamo sviluppato Air per rivoluzionare i nostri contenitori in plastica dedicati al picking: la struttura è rinforzata, la parete frontale con apertura a bocca di lupo espande la capacità contenitiva e allo stesso tempo aumenta l'ergonomia. Quest'innovazione incarna il nostro impegno non solo a migliorare la funzionalità, ma anche a garantire un utilizzo più confortevole ed efficiente. Sperimenta il livello successivo di soluzioni di storage con Air, dove la forza incontra il design.

A unique design: a more ergonomic handle, inserts for a firm stacking and reinforced edges. The aesthetic pattern on the bottom also has precise functions: to strengthen the box and distribute the weight forces.

Un design unico: maniglia più ergonomica, inserti per una salda sovrapposizione e bordi rinforzati. Anche il motivo estetico nel fondo ha delle precise funzioni: irrobustire la scatola e dissipare le forze peso.

Revolutionize your logistics, perfectly fitted for Europallet

Air is designed fully focused on the Europallet standard. We wanted to eliminate wasted space and optimise warehouse storage, allowing companies to store more containers in the same square footage.

We have obsessively sought this precision based on Europallet standards. Air allows an efficient organisation of the load during transport, cutting the number of trips required and significantly reducing fuel consumption and emissions.

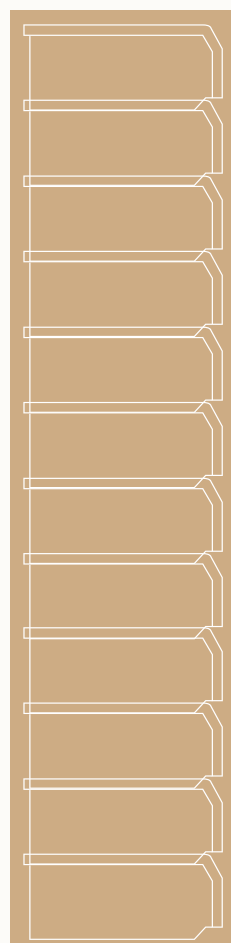

BEFORE

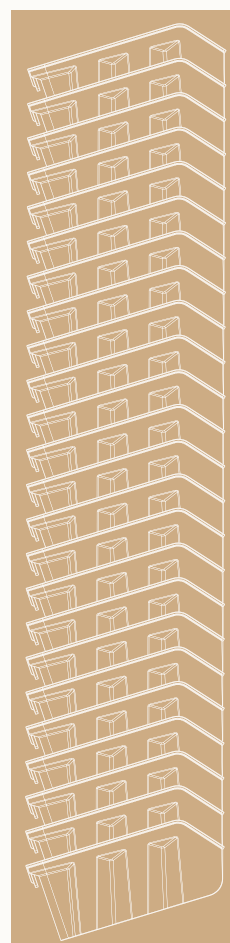

AFTER

Air è progettato con l'attenzione totale allo standard Europallet. Volevamo eliminare lo spazio sprecato e ottimizzare lo stoccaggio in magazzino, consentendo alle aziende di immagazzinare più contenitori nella stessa metratura.

Abbiamo ricercato ossessivamente questa precisione basandoci sugli standard Europallet. Air consente un'organizzazione efficiente del carico nel trasporto, riducendo il numero di viaggi necessari e diminuendo sensibilmente il consumo di carburante e di emissioni.

The product's nesting capacity is a great advantage for optimising production spaces in lean production systems, but it is an advantage that is already visible in the warehouse: the same space has greater value!

L'annidabilità del prodotto è un grande vantaggio nei sistemi con produzione lean per l'ottimizzazione degli spazi di produzione, ma è un vantaggio già visibile a magazzino: lo stesso spazio ha maggior valore!

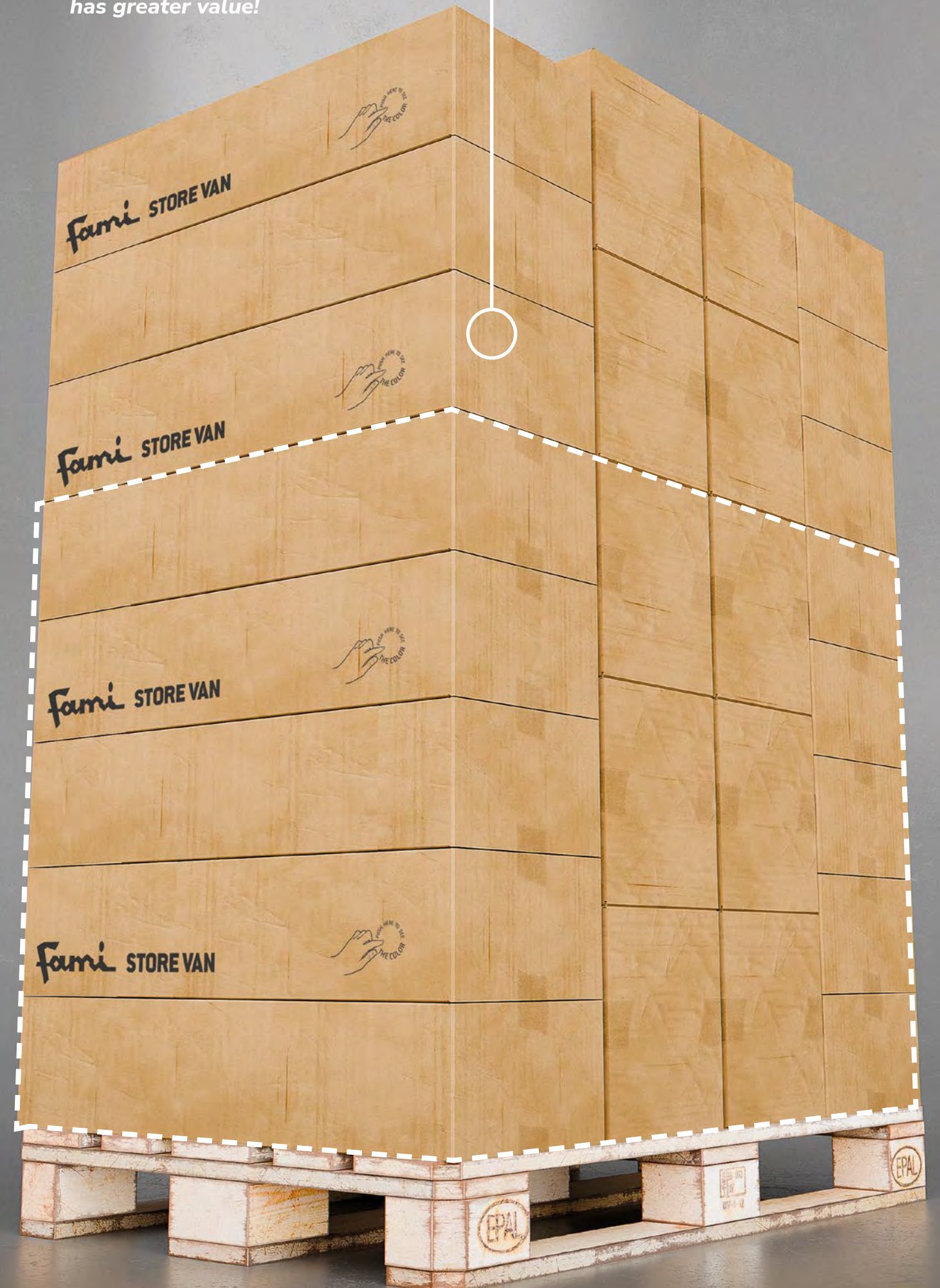

LESS space, LESS smog. MORE air.

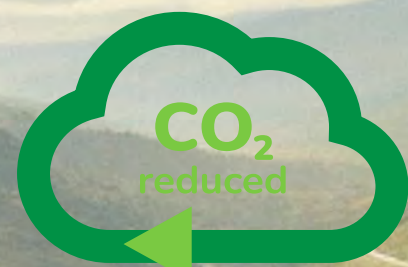

By adapting perfectly to Europallet standards, Air revolutionises logistics, maximising transport efficiency

Adattandosi perfettamente agli standard Europallet, Air rivoluziona la logistica massimizzando l'efficienza del trasporto

-57%*
of storage
consumption

di consumi da costi
di magazzinaggio

-27%*
of transport
consumption

di consumi da
movimentazioni interne

*The analysis examines the impact of Picking Box Air on the management of FAMI's internal storage and handling operations. The analysis was carried out by comparing the totality of the activities and the related consumption of traditional Picking Box containers in 2023 with the same quantity of activity recalculated based on the consumption necessary for storing and handling the Picking Box Air containers.

*L'analisi esamina l'impatto di Picking Box Air sulla gestione delle operazioni di stoccaggio e di movimentazione interne di FAMI. Il confronto è stato svolto comparando la totalità delle attività ed i relativi consumi del 2023 dei contenitori tradizionali Picking Box con la medesima quantità di attività ricalcolata sui consumi necessari a stoccaggio e movimentazione delle Picking Box Air.

Reducing our logistics volume has a profound impact on sustainability. Through rigorous analysis, we have revealed how FAMI's new Air containers revolutionise the reduction of CO2 emissions. The transition from the old to the new Picking Box in our logistics chain leads to a saving of over 10 tons of CO2. That's comparable to the environmental benefit of a forest of 70 birch trees!

- 10.633 kg less CO2
- 51.000 kWh less between electricity and gas
- 4.5 TOE less (tonnes of oil equivalent)



Ridurre il nostro volume logistico ha un profondo impatto sulla sostenibilità. Attraverso un'analisi rigorosa, abbiamo svelato come i nuovi contenitori Air di FAMI rivoluzionano la riduzione delle emissioni di CO2. Il passaggio dalle vecchie alle nuove Picking Box nella nostra catena logistica comporta un risparmio di oltre 10 tonnellate di CO2. È paragonabile al beneficio ambientale di una foresta di 70 betulle!

- 10.633 kg in meno di CO2
- 51.000 kWh in meno tra luce e gas
- 4,5 TEP in meno (tonnellate equivalenti di petrolio)

AIR

**BREATHE
THE EVOLUTION**



RK Box Air: Versatility, maximized

It's a drawer. Or a kanban container. Fixed suspended. Or with a guide on the shelf. Stackable. Separable. It is the innovative RK Box Air container by FAMI. A new standard in plastic containers: practically ready for anything. Our latest container redefines shelf storage through its adaptive design, ready to accommodate a wide selection of solutions and accessories. This adaptability makes it a cornerstone for any organisational challenge, offering the freedom to evolve your space as your needs change.

È un cassetto. O un contenitore kanban. Fissato sospeso. O con guida su ripiano. Impilabile. Suddivisibile. È l'innovativo RK Box Air di FAMI. Un nuovo standard nei contenitori in plastica: praticamente pronto a tutto. Il nostro ultimo contenitore ridefinisce lo stoccaggio a scaffale con il suo design adattivo, pronto ad accogliere un'ampia selezione di soluzioni e accessori. Questa adattabilità lo rende una pietra angolare per qualsiasi sfida organizzativa, offrendo la libertà di evolvere il tuo spazio man mano che le tue esigenze cambiano.



System ST: You can call it Super-Shelf



System ST di FAMI rivoluziona le scaffalature leggere. Il suo design innovativo è caratterizzato da giunti, ripiani e accessori facili da montare, consentendo diverse soluzioni di archiviazione: dagli scaffali angolari Kanban alle unità mobili, scatole espositive e ampie superfici di supporto fino a 2 metri. Questo sistema offre versatilità ed efficienza senza precedenti per varie esigenze organizzative, rendendolo una soluzione adattabile a qualsiasi spazio.

System ST by FAMI revolutionises lightweight shelving. Its innovative design features easy-to-assemble joints, shelves, and accessories, enabling diverse storage solutions: from Kanban corner shelves to mobile units, display boxes and large support surfaces of up to 2 metres.

This system offers unprecedented versatility and efficiency for various organisational needs, making it an adaptable solution for any space.

SYSTEM ST SHELVING
Can be integrated with the new containers of the Air line or with the storage solutions of the classic FAMI line.

SCAFFALI SYSTEM ST
Integrabili con i nuovi contenitori della linea Air o con le soluzioni di stoccaggio della linea classica FAMI.

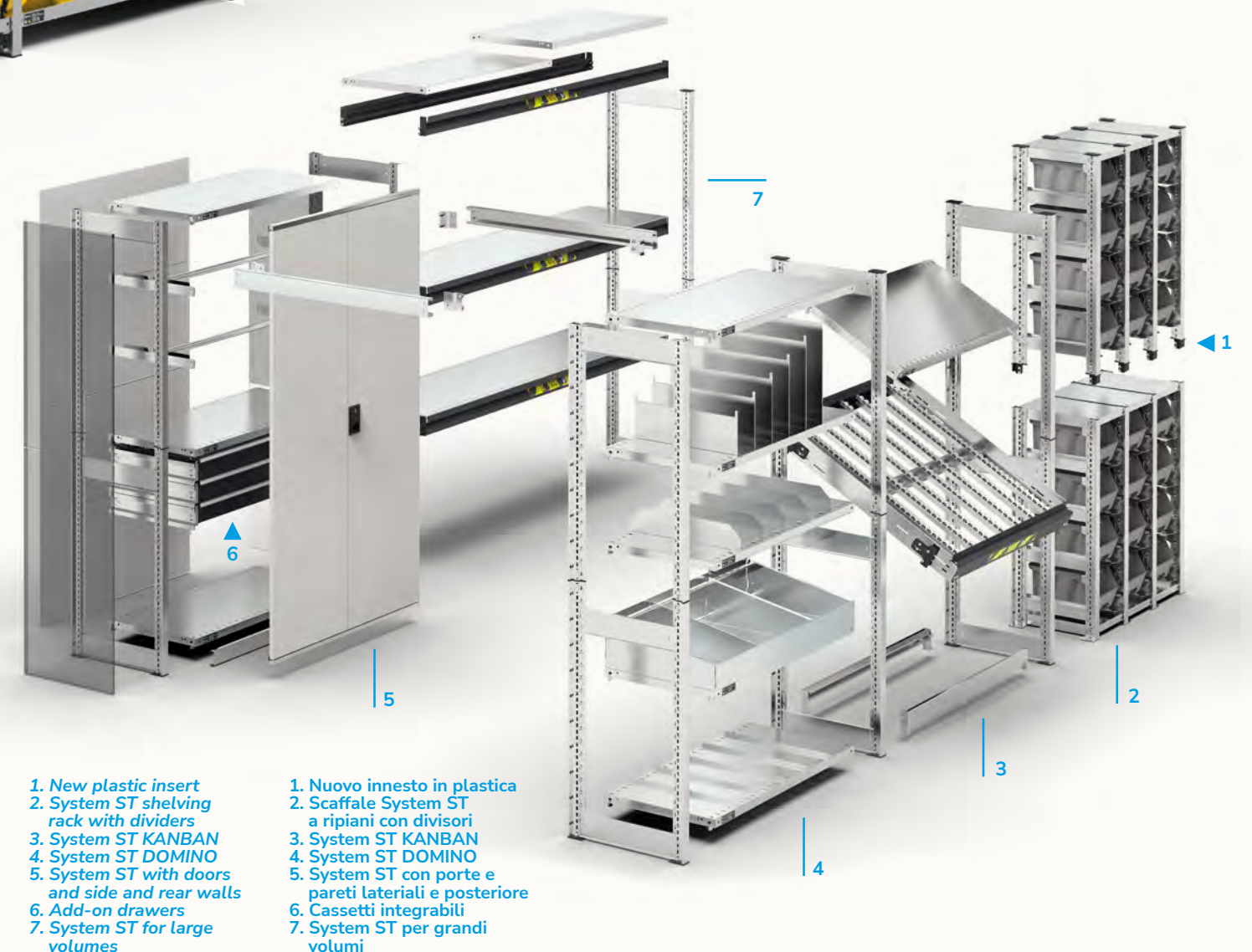

1. New plastic insert
2. System ST shelving rack with dividers
3. System ST KANBAN
4. System ST DOMINO
5. System ST with doors and side and rear walls
6. Add-on drawers
7. System ST for large volumes

1. Nuovo innesto in plastica
2. Scaffale System ST a ripiani con divisori
3. System ST KANBAN
4. System ST DOMINO
5. System ST con porte e pareti laterali e posteriore
6. Cassetti integrabili
7. System ST per grandi volumi



Picking Box Air



RK Box Air



Euro Box Classic

plastic
containers



Visual Box

visual
box



System ST



**Shelving with
inclined shelves**



**Shelving with roller
tracks and wheels**

storage
shelving



**Bin Cart Picking
Box Air**



**Bin Cart
Visual Box**

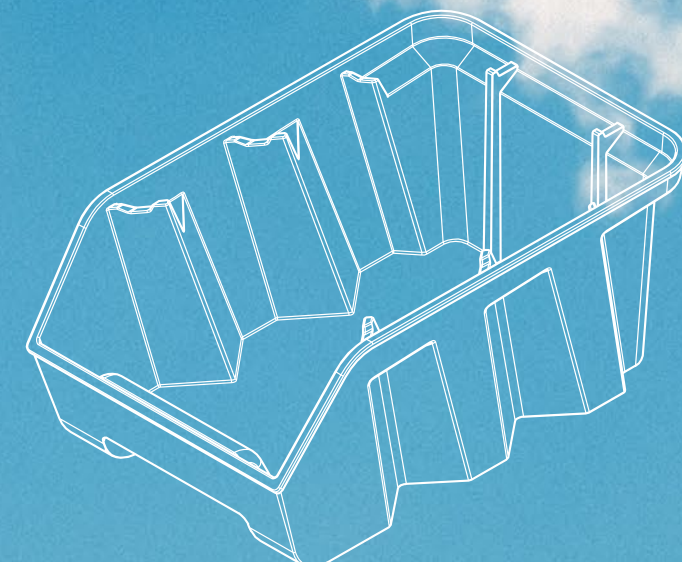
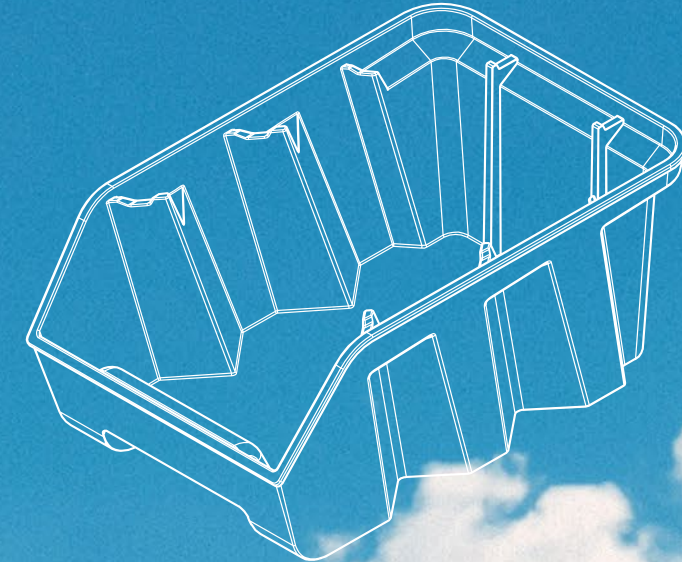

**Shaping plastic,
inspired by air**

AIR

**BREATHE
THE EVOLUTION**

AIR
BREATHE
THE EVOLUTION

fami

WWW.FAMISPA.COM

FAMI ONLINE STORE
shop.famispa.com

 Fami Srl  fami_storage_systems

 Fami Srl  FAMI S.r.l.

